

# **TECMEN<sup>®</sup>**

**Freflow V1**



## ***Powered Air Purifying Respirator***

---

Read all instructions and warnings before use. Users must understand this booklet prior to use. Keep these User Instructions for future reference. If you have questions regarding these products, just feel free to let Tecmen know.

Produced by **TECMEN<sup>®</sup>**

---

## WARNING

### USE FOR

This product with respiratory purifies certain airborne contaminants, including dust, pollutants, fine particles as well as other contaminants, welding dust and metal dust. Supplying clean air to the user's facial.

### DO NOT USE FOR

- Oxygen deficient atmospheres.
- Contaminant generated in workplace and concentrations that are unknown or immediately dangerous to life or health (IDLH).
- Oxygen concentration of the air in workplace is 19.5% or lower.
- Without complete assembling of the whole product, never use, which may cause danger for human life.
- Do not use in sealed place, in place with danger as fire, explosion.
- Do not use the product with its power turned off since carbon dioxide concentration may increase and oxygen level inside the face guard may decrease.
- Do not use if the product does not supply enough air. (MIN - 165 lpm)
- Do not use at workplace with strong wind. (as negative pressure generated inside the hood, outside-air comes into the hood)





### NOTICE

If beeping alarmed, immediately get away from the contaminated area and check the device. The hose may get blocked; Battery low power; Filter is dirty and need get changed with new one.

Please EXIT that contaminated place in any cases below:

- IF some problem is shown in any part of the product, for example, the air supply is stopped or its amount is decreased.
- IF it gets hard to breathe, feeling dizzy or headache, feeling the smell or taste of the contaminants and its stimulus occurred.
- Never use in place with too high level of contamination.
- Make sure the connecting hosepipe smooth and is not entangled or is in the way of other items in the area.
- Don't remove the respirator until you are in a safe area.
- Operating temperature range between -5°C and +55°C.
- The TECMEN Freflow PAPR system is not intrinsically safe. Keep away from flammable, or explosive atmosphere.
- At very high work rates the pressure in the device may become negative at peak inhalation flow.
- Do not confuse the European standard EN12941 with other standards.

### MARKINGS ON THE EQUIPMENT

 	Read the instruction before use.		Recycle
	Shall be disposed of as electronic waste.		Expiry date year/month

## DESCRIPTION & SPECIFICATION

This product with respiratory purifies certain airborne contaminants, including dust, pollutants, fine particles as well as other contaminants, welding dust, metal dust. Supplying clean air to the user's facial.

A complete Tecmen PAPR System includes a blower, filtration unit, breathing tube assembly, battery, and a welding helmet with auto darkening filter.

The blower assembly draws surrounding air through its filter and supplies purified air to the facial via a breathing tube. There are two levels airflow rate choice: Low speed—170+lpm; High speed—210+lpm. Switch the airflow by short press Button. Warning lights allow you to check the filter status. More warning lights turn on, more dirty it means. When warning lights flash, please replace the filter.

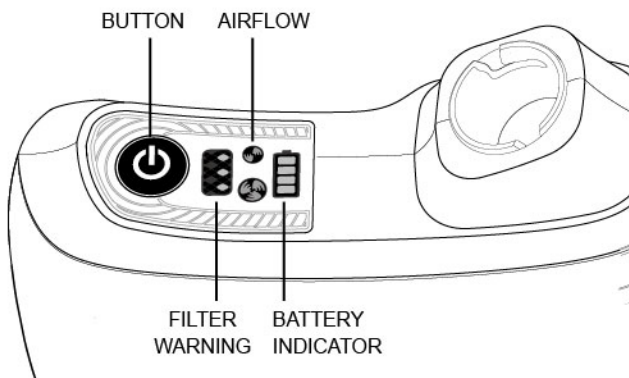

**Only Button controlling both Power On/Off and Airflow switch**

**1. Power On/Off**

On—Press and hold for 3 seconds.

Off—Press and hold for few seconds until beeping sounds finish.

**2. Airflow switch**

Press the Button to switch between 170+lpm and 210+lpm



Indicator light refers to the airflow state. Two different levels: Low Speed—170+lpm, High Speed—210+lpm



Display screen indicates the battery capacity.



Warning lights help to check the filter status. More light spots turn on, more dirty it means. When warning lights flash, pls. replace the filter.

---

**RESPIRATOR SPECIFICATIONS**

---

Airflow Rate	Manufacturer's minimum design flow rate: 165+lpm (5.8+cfm)
	Low speed: 170+lpm (6+cfm)
	High speed: 210+lpm(7.4+cfm)
Battery	Battery type: Rechargeable Li-ion Battery
	Battery duration: 9h-low speed(170+lpm); 5h-high speed(210+lpm)
	Battery charge time: 3 hours
	Battery life: 550 charges
Filter	Filter efficiency: 99.97%
	Alarms: Visible, Audible and Vibrate
Temperature	Operating temperature: 23°F to 131°F (-5°C to 55°C)
	Storage temperature: 14°F to 131°F (-10°C to 55°C)
Relative Humidity (R.H.)	Operating R.H.: < 90%
	Storage R.H.: < 85%
Weight (Blower+Battery)	1027 g
Respirator Approval	EN12941 TH2 — High level of respirator protection

# ASSEMBLING & SPARE PARTS

## FILTER



### WARNING



- Never use the respirator without the spark screen, pre-filter, and the HE particulate filter (HEPA) installed.
- Always replace filter when damaged or blocked. Do not try to wash, clean or reuse dirty ones.
- Fitting the filter into the blower unit, never directly to the helmet/hood.
- Stored at a temperature between 14°F to 131°F (-10°C to 55°C), in a clean environment without direct light.
- Remember not confuse the markings on a filter relating to any standard other than EN 12941 with the classification of this device when used with this filter.

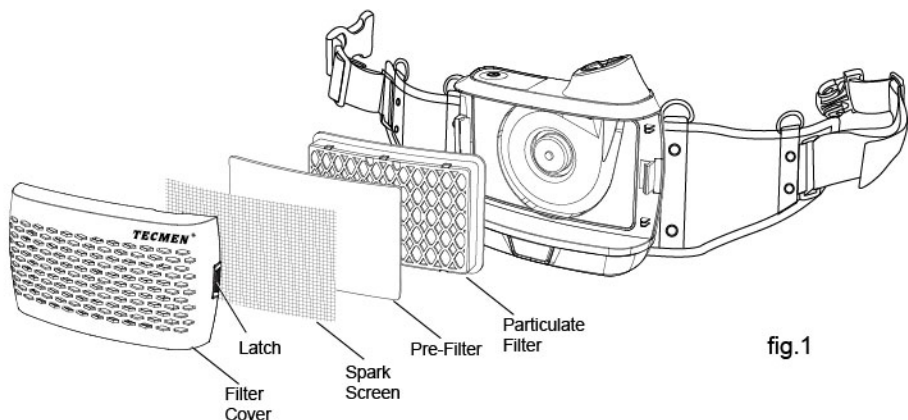

The power must be turned off when replacing the filters. Install the spark screen, pre-filter, and particulate filter in filter cover exactly as fig.1 shown.

Before installed, always make sure filter material is intact and dry with no tears or other damages. Install the filter cover assembly to the blower unit by engaging tabs on filter cover into bracket on blower unit and rotate assembly to close. Push filter cover assembly down until latch clicks into position securing filter cover assembly. Inspect both sides of cover to see that the filter cover is properly installed. To replace filter, push latch into release filter cover and replace filter as fig.2 shown.

**When to replace the filter:** If the filter gets blocked by contaminants, all the three points of warning lights will flash, accompanied with vibrate and bleeping sound. Please immediately exit contaminated environment and check the status.

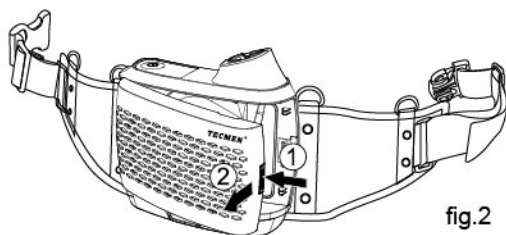

## BATTERY



### WARNING



- The battery should be charged in a place that is electrically safe.
- Full-charging takes about 3 hours. Charging time depends on the remaining battery capacity.
- Please check out the voltage of the charger (AC 110V~220V).
- Please separate the battery from the body before charging.
- Upon using-condition, the battery's life may be slightly different.

### Assembling/Disassembling the Battery

**How to disassemble the battery:** Push the button, take the battery out as fig.3a/3b/3c shown direction. Separate it from the body.

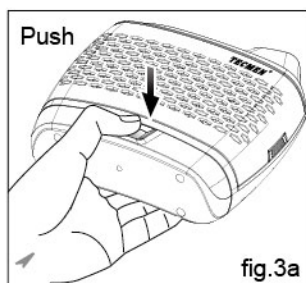

fig.3a

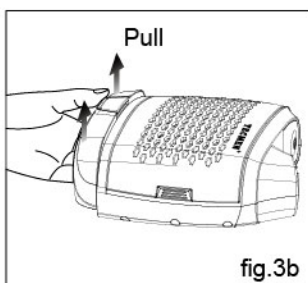

fig.3b

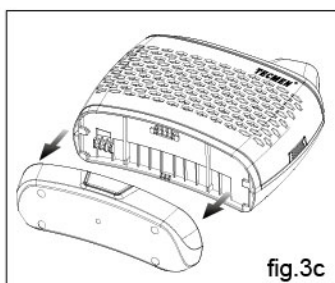

fig.3c

**How to assemble the battery:** Fitting the battery to the blower body, push until hearing 'Click' sound. (see fig.4a/4b)

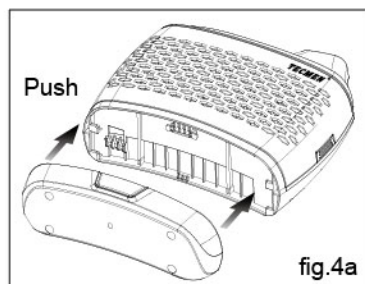

fig.4a

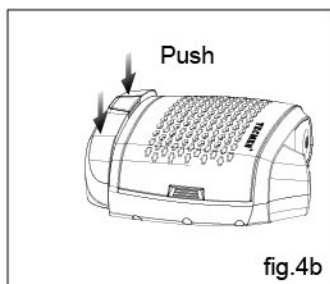

fig.4b

### Battery-charging

This indicator show the battery capacity.

When four sections show up, the battery is fully charged.

When just one section left (see fig.5), beeping sounds on, accompanied by vibration to remind users to stop work and get battery charged.

The frequency is beeping sounds occur every 30s seconds and vibration occurs every 2 minutes. After the warnings occur around 15 minutes, the battery indicator gets flashing, which shows there should be at most 15 minutes left before the blower off (Airflow low speed 170+lpm).

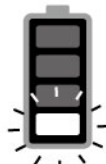
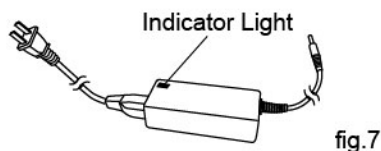
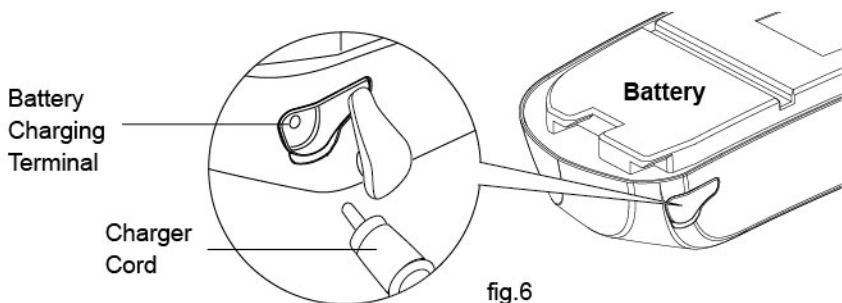

fig.5



Remove battery pack from blower assembly. Connect charger cord to battery terminal (see fig.6).

When the indicator light on charger turns from red to green(see fig.7) , never stop it immediately and please keep charging for another 0.5h.



#### Notice of battery use

- Do not put PAPR unit with power-on in the package. It's better to remove the battery from the body when put in the package.
- Do not keep PAPR unit inside the car in hot summer season.
- Do not throw or give the high impact to PAPR unit.
- Do not put PAPR unit on the electric heat generating equipment.
- Do not use any other battery charger.
- Battery operation time: 9 hours at low speed (170+lpm), 5 hours at high speed (210+lpm).
- Battery storage temperature: 14°F to 115°F (-10°C - 45°C), R.H.< 85%

---

## BREATHING TUBE

---



### WARNING



- Always inspect the PAPR end of the breathing tube to confirm the rubber O-ring is in place, see fig.9. Replace if missing or damaged.
- Be sure tube is properly installed and non-filtered air cannot enter the facial.

**Installation:** Insert the two prongs on the breathing tube into blower unit and helmet receptacle, twist 1/4 turn to the anti-“OPEN” direction to lock into place.(see fig.8)

**Disassembling:** Twist 1/4 to the “OPEN” direction and then take the prongs out from the end.(see fig.9)

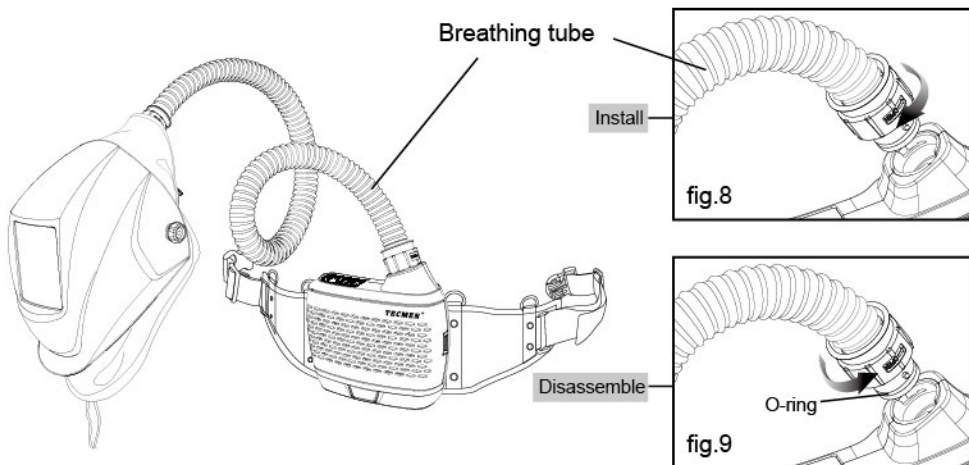

## SHOULDER STRAP & BELT CUSHION

Connect hooks to belt (see fig.10).

Connect with the blower by screw locking (see fig.11).

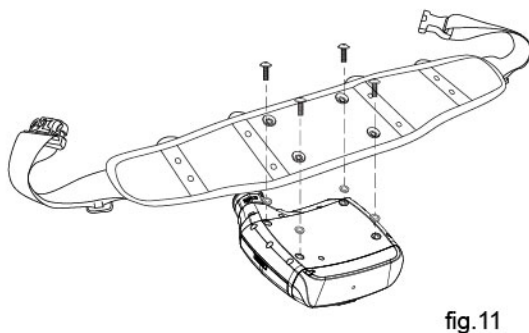
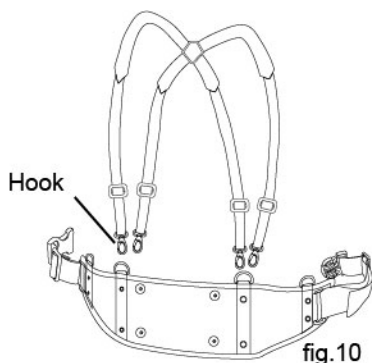

## AIR FLOW CONTROL

Two indicator lights on display (see fig.12). Low Speed-170+lpm; High Speed-210+lpm. When turn on the PAPR, default setting is low speed airflow; Switch the airflow by short press the Button (see fig.13).

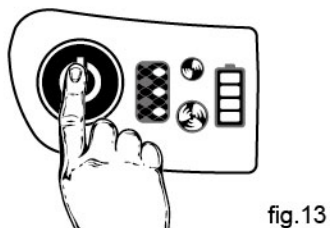
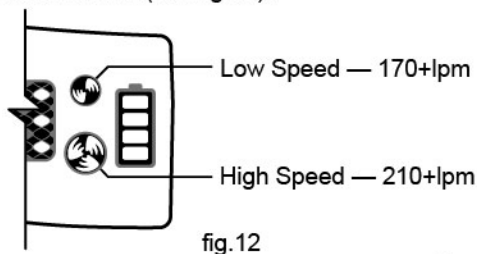



## ENTER AND EXIT CONTAMINATED AREA

### Before using Respirator - Check the following items.

1. Blower Assembly

Make sure the spark screen, pre-filter and particulate filter are properly installed and securely latched.

2. Breathing Tube

Make sure tube is not damaged and connected locked to the blower unit and helmet.

3. Battery

Check connection to blower unit is secure and battery is fully charged.

4. Airflow rate test / Alarm sound check

It's necessary to do both airflow rate test and alarm sound check before use. Testing method refers to page 9.

5. Face seal

Inspect face seal for damage and replace if necessary. Make sure the air is supplied to helmet.

### Always exit the contaminated area immediately if any of the following conditions occur:

- IF some problem is shown in any part of the product, for example, the air supply is stopped or its amount is decreased;
- IF it gets hard to breathe, feeling dizzy or headache, feeling the smell or taste of the contaminants and its stimulus occurred;
- NEVER use in place with too high level of contamination. If you suspect the levels reach a level which this respirator may no longer provide enough protection.

### Respirator removal



#### WARNING



- *Never remove the respirator in areas where the air is contaminated.*
- *Always take off the PAPR after you step out of the workplace.*

### Steps

- Take off helmet and disconnect tube from helmet.
- Turn off the blower by long press button.
- Release belt. Remove straps from shoulders and remove blower off of your lower back.

## SELF CHECK BEFORE EACH TIME USE

**ALL THE TESTS MUST ALWAYS BE DONE IN A SAFE ENVIRONMENT.**

### Alarm sound check

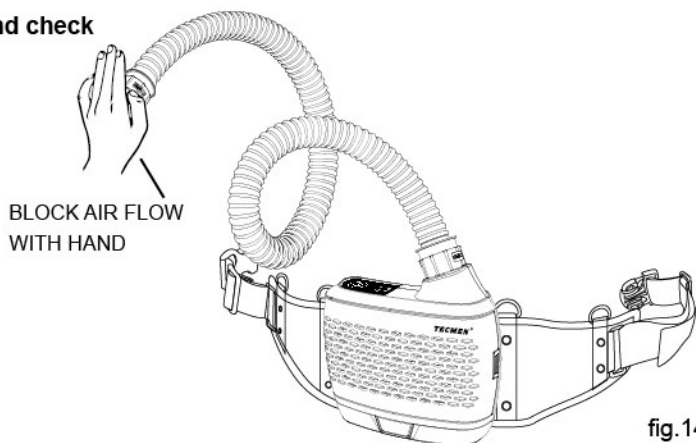

fig.14

After turning on the product, check the alarm sound warning function by blocking the air outlet as fig.14 shown in the picture above. The warning signal on the panel should flash with a sound and blower vibrate (approximately 15 to 30 seconds after the outlet is blocked). The product is working correctly if the warning functions follow the process above. (Please make sure the filter is equipped and the battery is fully charged before doing this test.)

### Airflow rate test

**Take airflow test always before using this product.**

Make sure all the components are fully assembled before testing.

Connect the end of hose to the bottom of airflow indicator and then start the Button. Keep the Flow Indicator vertical.(see fig.15)

If the ball inside the pipe floating above the limited line in low speed mode, it proves normal function.

If the ball cannot float up to limited line, please refer to Trouble-shooting Guide on page11.

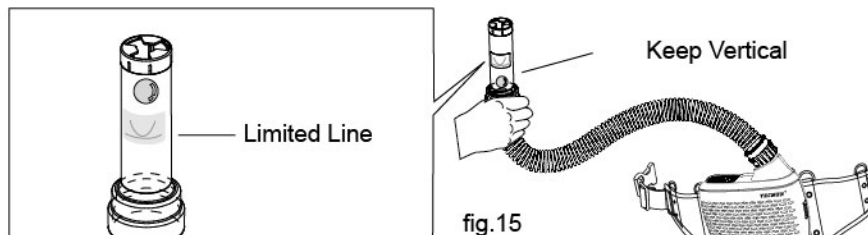

fig.15

## MAINTENANCE

The respirator components must be cleaned, inspected and prepared for next use after each use. Use soft cloth dipped in mild soap water for wiping. Be careful for the water NOT to get inside the body.

### CLEANING

1. Blower unit and battery pack: Clean the outer surfaces of the PAPR and battery pack with a soft cloth dampened in a solution of water and mild, pH neutral detergent. Be careful for the water NOT to get inside the body. Do not use solvents or abrasive cleaners. Ensure the electrical contacts of the motor/blower and battery pack are dry before assembling well.
2. Breathing tube: Wiping the exterior is insufficient. Clean the outer hose and connection on the breathing tube with the soft cloth dipped in water and detergent solution. Optional breathing tube covers can also be used to facilitate cleaning. Ensure the breathing tube is completely dry before using or storing. They cannot be immersed in liquids for cleaning and must be replaced if wet.
3. Filter: Open the filter cover and inspect all the filters and spark screens. The Particle and pre-filters cannot be cleaned. The spark screen can be cleaned using a clean, soft cloth dipped in a solution of water and a mild pH neutral detergent. Completely dry the spark screen with a clean cloth. Replace the pre-filter and Particle filter if excessively dirty, wet or damaged. Do not attempt to remove contamination using a compressed air line as this will automatically invalidate the warranty. If the spark screen cannot be cleaned or is damaged, replace with a new spark screen.

The face seal can be used to facilitate cleaning after disassembling from the shell, but it must be replaced if it is damaged.

## STORAGE

The TECMEN Freflow PAPR system is not intrinsically safe. Keep away from flammable, or explosive atmosphere. Storage should be in a clean, dry, cool place with filter.

### Blower storage

Stored at a temperature between 14°F to 131°F (-10°C to 55°C), in a clean environment without direct light.

### Battery storage

To help maximize battery service life:

- Disconnect the charger after a full charge has been received.
- Battery should be removed from blower if long time storage.
- Store the battery at 14°F to 115°F (-10°C to 45°C), R.H. <85%, to get maximize battery service life.

## TROUBLE-SHOOTING GUIDE

Problems	Causes	Trouble-shooting
No airflow from blower	Blower not ON	Long press ON button.
	Battery no power	Charge the battery.
	Battery not installed properly	Check and reassemble the battery.
	Tube blocked/air leakage	Check and clear the obstruction.
Airflow test failed	The hose may get blocked/air leakage	Check the tube status.
	Dirty filter needs replacement	Replace new filter.
Battery time is too short even fully charged	Battery faulty	Replace new battery.
	Incorrect charging	Fully charge battery.
	Blocked filter	Replace filter.
	Damaged charger	Replace a new charger.
Increased sound level	Filter is getting clogged	Replace filter and pre-filter as required.
Warning indicator ON, blower vibrate and alarm sound bleeping	Tube gets blocked/air leakage	Check if tube/anywhere gets blocked before use.
	Filter assembled without removing the package	Check if the package is removed.
Feeling smell of incoming air	Damaged Filter	Check the filter status and replace new one if needed.
	Hose with leakage problem	Check how the tube assemble as well as status.
	Filter component not complete	Check and equip both filters.

## WELDING HELMET OPERATING INSTRUCTION



### WARNING



Auto-Darkening welding helmets are designed to protect the eye and face from sparks, spatter and harmful radiation under normal welding conditions. Auto-Darkening filter automatically changes from a light state to a dark state when an arc is struck, and it returns to the light state when welding stops.

**The Auto-Darkening welding helmet comes assembled. But before it can be used, it must be adjusted to fit the user properly. Check battery surfaces and contacts and clean it if necessary. Verify if the battery is in good condition and installed properly. Set up for delay time, sensitivity and shade number for your application.**

**The helmet should be stored in dry, cool and dark area and remove the battery, when not using it for a long time.**

## COMMON PROBLEMS AND REMEDIES

### • Irregular Darkening Dimming

Headband has been set unevenly and there is an uneven distance from the eyes to the filter lens. (Reset the headband to reduce the difference to the filter).

### • Auto-Darkening filter does not darken or flickers

- ① Front cover lens is soiled or damaged (Change the cover lens).
- ② Sensors are soiled (Clean the sensors surface).
- ③ Welding current is too low (Adjust the sensitivity level to higher).
- ④ Check battery and verify they are in good condition and installed properly. Also, check battery surfaces and contacts and clean if necessary.

### • Slow response

Operating temperature is too low (Do not use at temperatures below -5°C or 23°F).

### • Poor vision

- ① Front/inside cover lens and/or the filter is soiled (Change lens).
- ② There is insufficient ambient light.
- ③ Shade number is incorrectly set (Reset the shade number).
- ④ Check if removing the film on the front cover lens.

### • Welding helmet slips

Headband is not properly adjusted (Readjust the headband).



### WARNING



The user must stop using the auto-darkening welding helmet immediately if the above-mentioned problems cannot be corrected. Contact the dealer.

## CARTRIDGE OPERATION

### • POWER

When the low battery LED located on the lens starts to come to red, it is a warning for the battery to be replaced.

• Slide the battery holder out of the auto darkening filter, (remove the used battery when you replacing battery), put new CR2450 battery inside the battery holder, and put the battery holder back into the auto darkening filter.

Please make sure the anode and cathode of the battery are installed correctly. (See fig.16)

Be sure Positive (+) side of battery faces up.

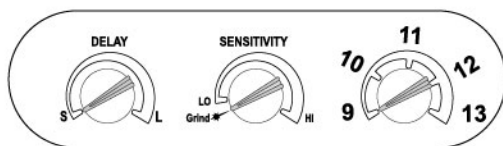
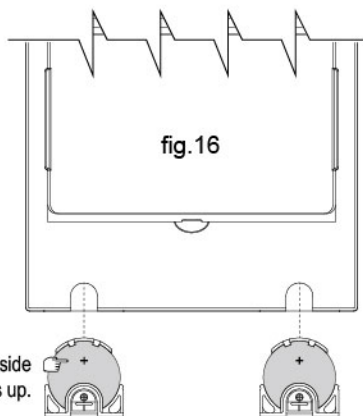

### • SELECTING SHADE LEVEL

Select the shade level you require according to the welding process you will use by referring to the "Shade Guide Table" below for settings. Turn the shade control knob on the lens to the shade number required.

### • SELECTING DELAY TIME

When welding ceases, the viewing window automatically changes from dark back to light but with a pre-set delay to compensate for any bright afterglow on the workpiece. The delay time / response can be set to " S " (short: 0.1 sec.) or " L " (long: 1.0 sec.). As you require using the infinitely dial knob on the back of the shade cartridge (See fig.17). It is recommended to use a shorter delay with spot welding applications and a long delay with applications using higher currents. Longer delays can also be used for lower current TIG welding, and TIG / MIG / MAG pulse.

### • SENSITIVITY

The sensitivity can be set to " H "(high) or " L "(low) by using the infinitely dial knob on the back of the shade cartridge. The "Mid-High" setting is the normal setting for everyday use. The maximum sensitivity level is appropriate for low welding current work, TIG, or special applications. Higher sensitivity setting is necessary if lens flashing on and off. Where the operation of the helmet is disturbed by excess ambient light, or another welding machine close by, use the "low" setting (See fig.17). As a simple rule for optimum performance, it is recommended to set sensitivity to the maximum at the beginning and then gradually reduce it, until the filter reacts only to the welding light flash and without annoying spurious triggering due to ambient light conditions (direct sun, intensive artificial light, neighbouring welder's arcs etc.).



## • SELECTING THE GRIND OPTION

When the sensitivity knob is turned to the “grind” position, the shade function is turned off allowing a clear view to grind a weld with the helmet providing face protection. Before restarting welding work, ensure that the shade function is turned back on before welding again(See fig.17).

## • ADJUSTING THE FIT OF THE HELMET

The overall circumference of the headband can be made larger or smaller by rotating the knob on the back of the headband. (See adjustment “Y” in fig.18). This can be done while wearing the helmet and allows just the right tension to be set to keep the helmet firmly on the head without it being too tight.

- If the headband is riding too high or too low on your head, adjust the strap which passes over the top of your head. To do this release the end of the band by pushing the locking pin out of the hole in the band. Slide the two portions of the band to a greater or lesser width as required and push the locking pin through the nearest hole. (See adjustment “W” in fig.18).
- Test the fit of the headband by lifting up and closing down the helmet a few times while wearing it. If the headband moves while tilting, re-adjust it until it is stable.

## • ADJUSTING THE DISTANCE BETWEEN THE HELMET AND THE FACE

Step 1: Undo the block nut (See “T” in fig.18) to adjust the distance between the helmet and your face in the down position.

Step 2: Loosen the block nut on either side of the helmet and slide it nearer or further from your face. (See adjustment “Z” in fig.18). It is important that your eyes are each the same distance from the lens. Otherwise the darkening effect may appear uneven.

Step 3: Re-tighten the block nut when adjustment is complete.

## • ADJUSTING VIEW ANGLE POSITION

TILT: Tilt adjustment is located on right side of helmet. Loosen the right block nut and push the top end of the adjustment lever outward until the lever’s Stop Tab clears the notches. Then rotate the lever forward or back to the desired tilt position, no need to remove the face-seal. The Stop will automatically engage again when released locking the helmet into position (See fig.19).

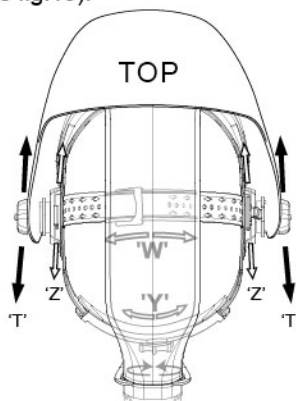

fig.18

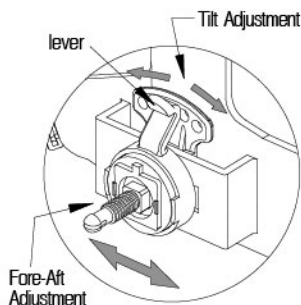

fig.19

## SHADE GUIDE TABLE

(No.1)

Welding Process	ARC CURRENT (Amperes)													
	0.5	2.5	10	20	40	80	125	175	225	275	350	450		
	1	5	15	30	60	100	150	200	250	300	400	500		
SMAW				9	10		11		12		13		14	
MIG (heavy)							10	11	12		13		14	
MIG (light)							10	11	12	13	14	15		
TIG, GTAW			9	10	11	12	13						14	
MAG/CO2						10	11	12	13		14		15	
SAW								10	11	12	13	14	15	
PAC							11	12		13				
PAW			8	9	10	11	12	13		14			15	

### NOTE:

SMAW – Shielded Metal Arc Welding  
 TIG, GTAW – Gas Tungsten Arc Welding  
 PAC – Plasma Arc Cutting  
 SAW – Shielded Semi-Automatic Arc Welding

MIG (Heavy) – MIG on Heavy Metals  
 PAW – Plasma Arc Welding  
 MAG/CO2 - Metal Active Gas  
 MIG (Light) – MIG on Light Alloys

## MAINTENANCE

To replace the front cover lense remove lens cassette by moving locks toward center (see fig.20) and lift up the lens cassette to remove/replace the front lens cover.

**REPLACING INSIDE CLEAR LENS :** Replace the inside clear lens if it is damaged. Place your fingernail in recess below cartridge view window and flex lens upwards until it releases from edges of cartridge view window.

**CHANGE THE SHADE CARTRIDGE :** Remove ADF holder assembly from helmet shell. See fig.20 for removal. Flex top end of the ADF holder to allow for ADF cartridge to be removed from frame. Install new ADF cartridge into frame per fig.21 below. Make sure that the ADF cartridge is inserted in ADF holder correctly as shown. Install ADF holder assembly into helmet shell.

**CLEANING.** Clean helmet by wiping with a soft cloth. Clean cartridge surfaces regularly. Do not use strong cleaning solutions. Clean sensors and solar cells with methylated spirit and a clean cloth and wipe dry with a lint-free cloth.

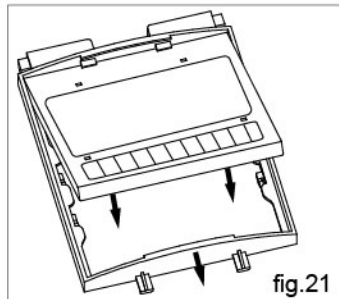
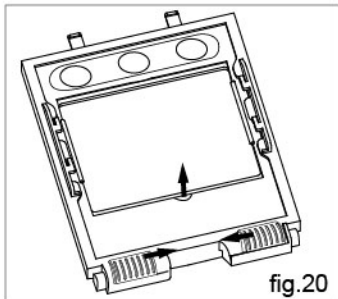

## TECHNICAL SPECIFICATIONS

Optical Class:	1 / 1 / 1 / 2
Viewing Area:	97 x 62 mm (3.82" x 2.44")
Cartridge Size:	133 x 114 x 9 mm (5.25" x 4.50" x 0.35")
Arc Sensor:	4
Light State:	DIN 3.5
Dark State:	DIN 9 ~ 13
Shade Control:	Internal, Variable Shade
Power On/Off:	Fully Automatic
Sensitivity Control:	Low — High, Adjustable Infinitely
UV/IR Protection:	Up to Shade DIN16 at all times
Power Supply:	Solar cell. Battery Replaceable, 2 × CR2450 lithium battery
Switching Time:	1/25,000 s. from Light to Dark
Delay (Dark to Light):	0.1 ~ 1.0s by dial control knob
Low Amperage TIG Rated:	≥ 2 amps (DC); ≥ 2 amps (AC)
Grinding:	Yes
Operating Temp.:	-5°C ~ +55°C (23°F ~ 131°F)
Storing Temp.:	-10°C ~ +70°C (14°F ~ 158°F)
Helmet Material:	High Impact Resistance Nylon
ADF Weight:	160g
Application range:	Stick Welding (SMAW); TIG DC&AC; TIG Pulse DC; TIG Pulse AC; MIG/MAG/CO <sub>2</sub> ; MIG/MAG Pulse; Plasma Arc Cutting (PAC); Plasma Arc Welding (PAW); Air Carbon Arc Cutting (CAC-A); Grinding
Approved:	DINplus, CE, ANSI Z87.1, CSA Z94.3, AS/NZS 1338.1

# PART LIST

## General Assembly

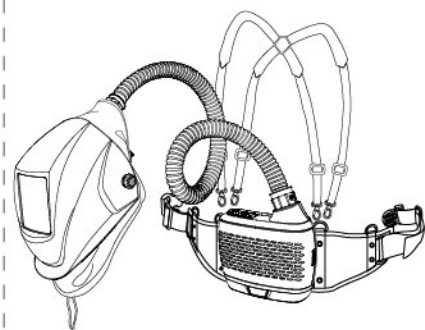

## A

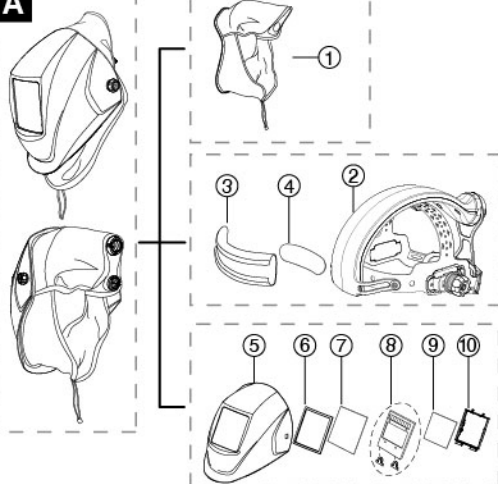

## B

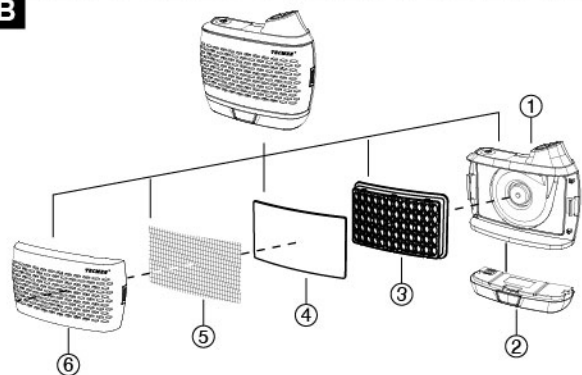

## C

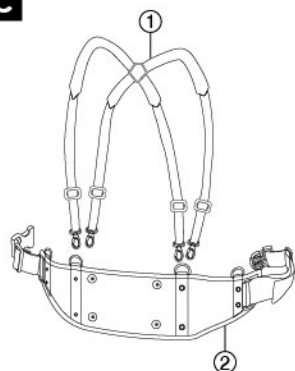

## D

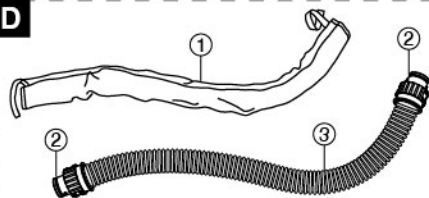

## E

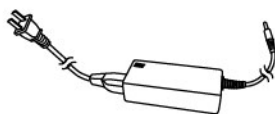

## F



**PART LIST****A. Tecmen PAPR Helmet Assembly**

ITEM	PART NO.	DESCRIPTION
A-1	V1FS TM16 00	Face seal
A-2	V1HG TM16 00	Headgear (Including Plenum)
A-3	V1SW TM3 00	Sweatband
A-4	V1SP TM3 00	Soft pad
A-5	V1PH TM16 00	Helmet shell
A-6	RF TM11 01	rubber frame
A-7	FC TM05 01	Outside cover lens
A-8	ADF800S	Auto darkening filter
A-9	IC TM 800S 00	Inside cover lens
A-10	HD TM16 01	Lens holder

**B. Blower Unit**

ITEM	PART NO.	DESCRIPTION
B-1	V1BM TM3 00	Body
B-2	V1BA TM3 00	Battery
B-3	V1P3 TM3 00	Particle filter (P3 Filter)
B-4	V1PF TM3 00	Pre-filter
B-5	V1SS TM3 00	Spark screen
B-6	V1FC TM3 03	Filter cover

**C. Wears**

ITEM	PART NO.	DESCRIPTION
C-1	V1SH TM3 00	Shoulder strap
C-2	V1BE TM3 00	Belt cushion (Include Screws & Washers)

**D. Hose**

ITEM	PART NO.	DESCRIPTION
D-1	V1HC TM3 00	Hose cover
D-2	V1OR TM3 00	O-ring
D-3	V1HO TM3 00	Hose

**E. Battery Charger**

ITEM	PART NO.	DESCRIPTION
E	V1BC TM3 00	Battery charger

**F. Airflow Indicator**

ITEM	PART NO.	DESCRIPTION
F	V1AI TM3 00	Airflow indicator

## WARRANTY

Tecmen's only obligation shall be repair, replace or refund the purchase price of such parts or products material and fabrication defects free of charge within the warranty period.

This warranty does not cover to cause by improper handling abuse or application other than recommended in the user instruction.

If you come across any problem during warranty period, contact your distributor, send the defective parts together with the completed defect problem if necessary.

-----

Thank you very much for choosing a TECMEN® product!

For future reference, please complete the owner's record below:

**Serial Number:**

**Purchase Date:**

-----